

GPO60

Multipole Power Connector



特征

FEATURES

• 平面接触技术

强电流下接触电阻最小,断开过程中产生的擦拭动作可清洁接触件表面

• Flat wiping contact system

Minimal contact resistance at high current, wiping action cleans contact surface during connection/disconnection

• 彩色防呆设计

根据颜色确定行业标准推荐的使用电压,避免两个带有不同电压编码颜色的胶壳配插(消除电源与插座误插的可能性)

• Mechanical keyed housings

Prevents accidental mating of components operating at different voltage levels

• 互换无公母设计

互换性设计,无公母外壳,利于减少库存

• Interchangeable genderless design

Makes assembly easy and reduces stock

• 防金手指设计

大大降低了生活中电路的潜在风险,依照 IEC60950 标准

• Touch safe interface

Minimizes potential contact with live circuits per IEC60950

PRODUCT SPECIFICATIONS/产品规格

Current Rating (Amperes) 额定电流 (安培)	60A
Voltage Ratings (Volts) 额定电压 (伏特)	600
Contact Barrel Wire Size (AWG/ mm ²) 适用线径 (AWG/ mm ²)	AWG# 6 13.3mm ²
Maximum Wire Insulation Diameter (mm/ inches) 最大绝缘导线直径 (毫米/英寸)	11.2 mm (0.44 inches)
AVG Contact Resistance(micro-ohms) 接触电阻 (微欧)	200
Insulation Withstanding Test Voltage (Volts AC/DC) 绝缘耐电压 (交流/直流)	2200
Contact Retention Force (lbf)端子保持力 (磅)	50
Life/寿命	
a. No load (Contact/Disconnect Cycles)无负载 (插拔次数)	To 10,000
b. Under Load (Hot Plug 250 cycles @ 120V)负载状态 (120V 电压插拔 250 次)	60 A
Avg. Connection/Disconnect (lbf) 平均插拔力 (磅)	50
Operating Temperature Range °C 工作温度 °F	-20° to 105°/-4° to 221°
Flammability Rating of Housing Material 材料防火等级 Plastic(塑胶壳) Polycarbonate and PBT Contact(端子) Copper Alloy Silver plating and Tin plating and Gold plating	UL94 V-0

Your Best High Power Connection



Shenzhen Grid Power Connectors Co., Ltd

Tel: +86 0755-23208099 23205933

Address: The 2nd Floor, Building B&C, Plant 1, Senyang ,
Technology Park, Guangming District, Shenzhen City, PRC
www.gridpower-conn.com www.grd-power.com

GPO60

Multipole Power Connector



HOUSING/胶壳

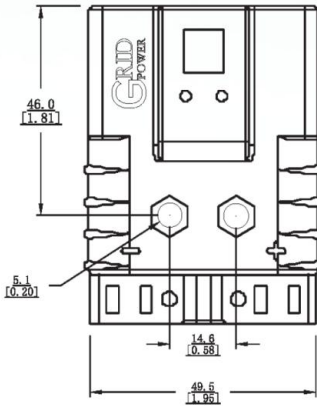

Part Number 料号	PBT Number (PBT) 料号	Housing Color 胶壳颜色
GPO60G1	GPO60G1-P	Gray 灰色
GPO60G2	GPO60G2-P	Red 红色
GPO60G3	GPO60G3-P	Black 黑色
GPO60G4	GPO60G4-P	Blue 蓝色
GPO60G5	GPO60G5-P	Yellow 黄色
GPO60G6	GPO60G6-P	Green 绿色
GPO60G7	GPO60G7-P	Orange 橙色
GPO60G8	GPO60G8-P	Brown 棕色
GPO60G9	GPO60G9-P	White 白色

Primary Power Contacts /接触件

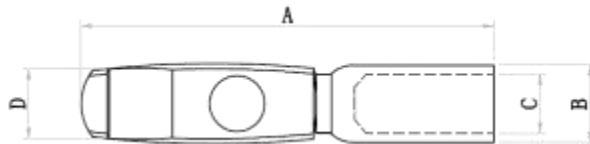

Part Number 料号	Description 描述	Mating Force 配合力	Wire Size/线径		- A -		- B -		- C -		- D -		
			AWG	Sq.mm	mm	In	mm	In	mm	In	mm	In	
A1	S1339G1	Individual 单粒	High 高	#6	13.3	39.4	1.55	7.3	0.29	5.6	0.22	7.6	0.3
A2	S1339G2	Individual 单粒	Low 低	#6	13.3	39.4	1.55	7.3	0.29	5.6	0.22	7.6	0.3
A3	S1339G3	Individual 单粒	Low 低	#10#12	5.3/3.3	39.4	1.55	7.3	0.29	3.5	0.14	7.6	0.3
A4	S1339G5	Individual 单粒	Low 低	#8	8.4	39.4	1.55	7.3	0.29	4.7	0.19	7.6	0.3

TEMPERATURE RISE CHARTS /温升测试

Temperature Rise at Constant Current/温升曲线

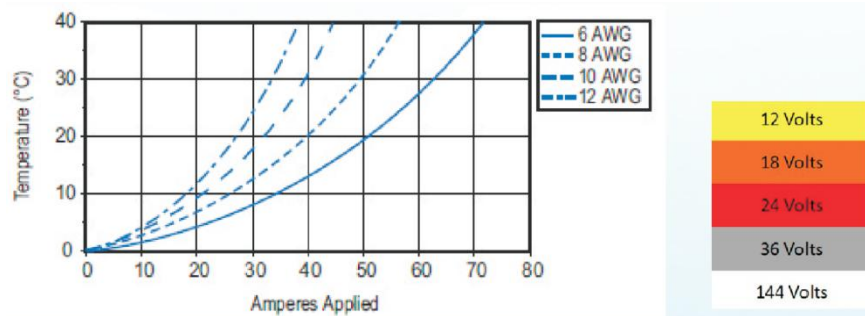

Your Best High Power Connection



E357218

Shenzhen Grid Power Connectors Co., Ltd

Tel: +86 0755-23208099 23205933

Address: The 2nd Floor, Building B&C, Plant 1, Senyang ,
Technology Park, Guangming District, Shenzhen City, PRC
www.gridpower-conn.com www.grd-power.com

GPO60

Multipole Power Connector

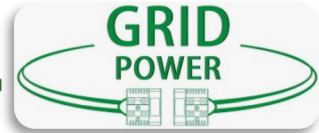

T TYPE HANDLE / T 型拉手

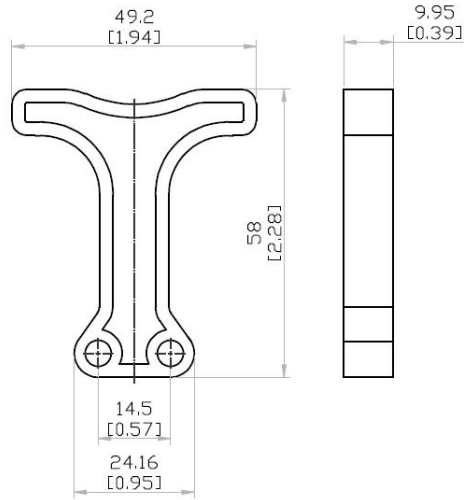
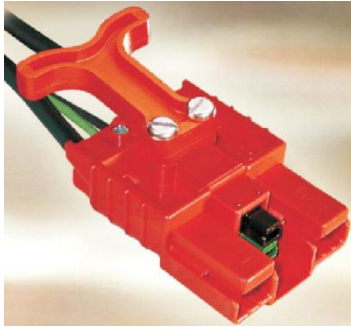

Part Number / 料号	Color / 颜色
GBE80HDL-RED	Red 红色
GPE80HDL-BLK	Black 黑色

CABLE CLAMPS/线扣

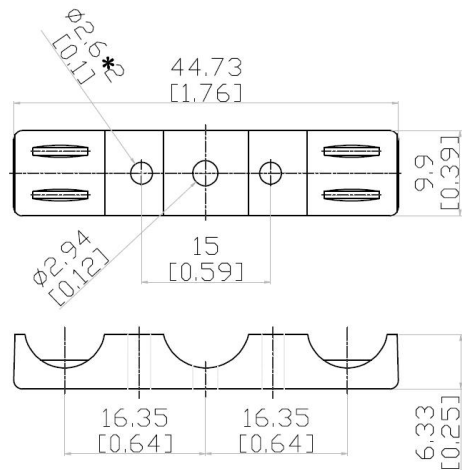

Part Number / 料号	Color / 颜色
GBE80CLPRED	Red 红色

GPX4P HOUSING/GPX4P 胶壳

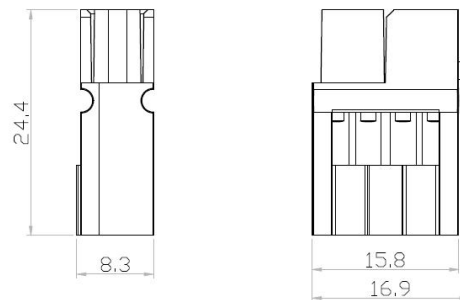

Part Number/料号	Color/颜色
GPX4PG2	Red 红色
GPX4PG1	Black 黑色

Your Best High Power Connection



E357218

Shenzhen Grid Power Connectors Co., Ltd

Tel: +86 0755-23208099 23205933

Address: The 2nd Floor, Building B&C, Plant 1, Senyang ,
Technology Park, Guangming District, Shenzhen City, PRC
www.gridpower-conn.com www.grid-power.com

GPO60

Multipole Power Connector

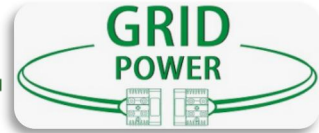

Pin Contacts for GPX4P Auxiliary/信号针

Part Number 料号	Description 描述	Wire Size/线径		-L-		-L1-		-ID-	
		AWG	sq. mm	mm	In.	mm	In.	mm	In.
SPM16P12S30	Standard Length 7.7mm	#12	3.3	19.5	0.77	7.7	0.30	2.6	0.10
SPM16P1416S30		#14/#16	1.5/1.0	19.5	0.77	7.7	0.30	2.1	0.08
SPM16P1620S30		#16/#20	1.0/0.75	19.5	0.77	7.7	0.30	1.7	0.07
SPM16P2024S30		#20/#24	0.75/0.5	19.5	0.77	7.7	0.30	1.1	0.04
SPM16P12A30	Pre-Mate 9.3mm	#12	3.3	21.2	0.83	9.3	0.37	2.6	0.10
SPM16P1416A30		#14/#16	1.5/1.0	21.2	0.83	9.3	0.37	2.1	0.08
SPM16P1620A30		#16/#20	1.0/0.75	21.2	0.83	9.3	0.37	1.7	0.07
SPM16P2024A30		#20/#24	0.75/0.5	21.2	0.83	9.3	0.37	1.1	0.04
SPM16P12C30	Post-Mate 6.4mm	#12	3.3	18.3	0.72	6.4	0.25	2.6	0.10
SPM16P1416C30		#14/#16	1.5/1.0	18.3	0.72	6.4	0.25	2.1	0.08
SPM16P1620C30		#16/#20	1.0/0.75	18.3	0.72	6.4	0.25	1.7	0.07
SPM16P2024C30		#20/#24	0.75/0.5	18.3	0.72	6.4	0.25	1.1	0.04

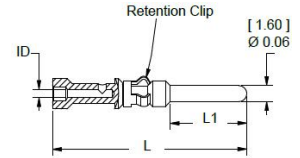

Socket Contacts for GPX4P Auxiliary/信号针

Part Number 料号	Description 描述	Wire Size/线径		-ID-	
		AWG	sq. mm	mm	In.
SPM16S12S32	Socket Contact	#12	3.3	2.6	0.10
SPM16S1416S32		#14/#16	1.5/1.0	2.1	0.08
SPM16S1620S32		#16/#20	1.0/0.75	1.7	0.07
SPM16S2024S32		#20/#24	0.75/0.5	1.1	0.04

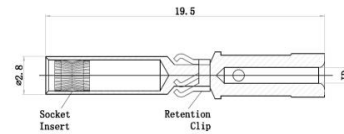

INSERT SOOL/送针器



Part Number 料号

75x10001

Accessories/附件

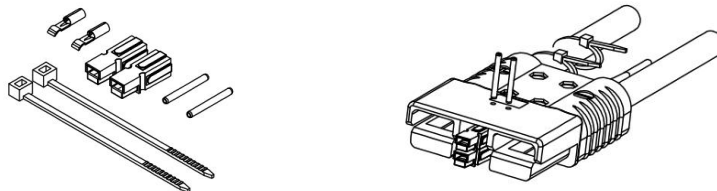

Part Number/料号	Description 描述
G6344	G1327 、 G1327G6 、 S1331 、 G110G9 、 H1509P12

Your Best High Power Connection



Shenzhen Grid Power Connectors Co., Ltd

Tel: +86 0755-23208099 23205933

Address: The 2nd Floor, Building B&C, Plant 1, Senyang ,
Technology Park, Guangming District, Shenzhen City, PRC
www.gridpower-conn.com www.grd-power.com